



Automation for a Changing World

Delta Hybrid Energy Saving System HES-C Series



www.deltaww.com

 **DELTA**
Smarter. Greener. Together.

Delta Hybrid Energy Saving System

HES-C Series

Based on the mission statement, "To provide innovative, clean and energy-efficient solutions for a better tomorrow", Delta is committed to developing advanced variable frequency control technology for enhanced efficiency and greater energy-savings. Plastic products are widely used in our living environment for daily commodities, electronic devices and automotive components. Injection molding machines play a key role in plastic products production. There are four major energy consuming units in a traditional injection molding machine including the hydraulic pump, the heating unit, the cooling system, and the control system components. The hydraulic pump system consumes the most energy and accounts for more than 75% of the total power consumption in an injection molding manufacturing process. An injection molding cycle consists of several stages from mold closing, injection, pressure holding, plasticization, mold opening to ejection. Each stage requires a different pressure and flow. The oil pump motor is under variable loading. Traditionally, the overflow valve and the ratio valve adjust the excess pressure and flow that occurs at each stage. This process is known as "high-pressure throttle". It accounts for 40%~75% of the energy lost. The Delta Hybrid Energy Saving System HES-C Series provides precise pressure and flow control, eliminating energy loss in the high pressure throttle process. It helps injection molding machines save energy while enhancing productivity and precision. The Delta HES Series provides the best solution for injection molding machines.

Ultra Energy-Saving

- Saves up to **75%** power consumption depending on the different injection conditions

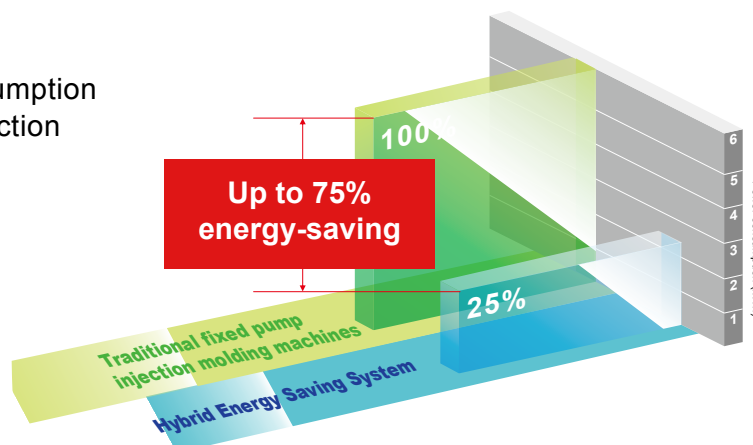

Energy Consumption Curve of the Injection Molding Process

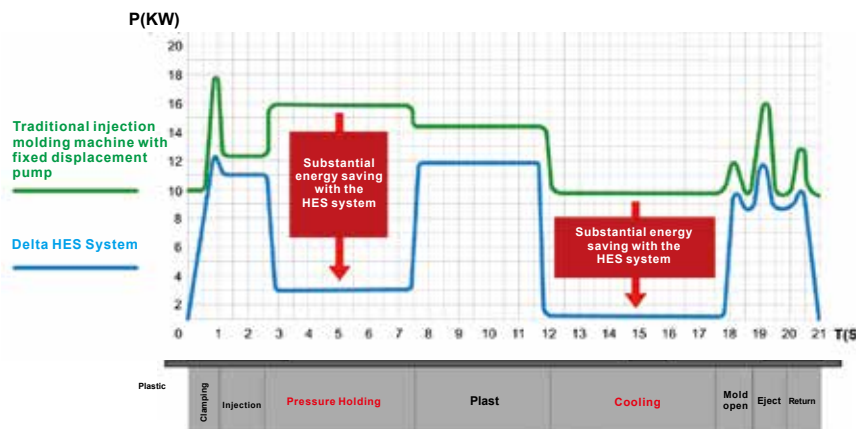

System Features

(1) Significant Energy Reduction

- A field test with an 850-ton injection molding machine adopted the Delta HES250M43 double-pump confluence hydraulic system.
- The Delta HES-C Series saved up to **109,500 kWh** in energy consumption and reduced **69,861 kg** CO₂e emissions in a year compared with competing products operating 24 hours per day.

850T Injection Molding Machine	Delta		Competitor 1		Competitor 2	
Double-Pump Operation Hydraulic System	Master Pump 125cc	Slave Pump 125cc	Master Pump 125cc	Slave Pump 125cc	Master Pump 100cc	Slave Pump 100cc
Power Consumption (kWH)	5.63	5.22	8.01	6.96	11.84	11.52

(2) Excellent Overload Capability

- All HES-C models feature overload capability of max. pressure 175bar for 60 seconds, and some of the advanced models can reach max. 8 minutes. All these models are especially suitable for is especially suitable for thick products production. Please refer to the Pressure-Flow Characteristic Chart on the following pages for more details.

(3) Cost-Effective System

- Delta Hybrid Energy Saving System HES-C adopts Hybrid Servo Drive VFD-VJ Series and Fan Cooling Servo Motor MSJ Series, and features high torque and low inertia. Allowing users to select Hybrid Servo Drive VFD-VJ Series and Servo motor MSJ Series with lower power rating to save system cost.

(4) PID Pressure Control

- Using Delta's special PID control technique, the system is able to perform pressure overshoot under **3 bar** with optimized response time and stable product weight.

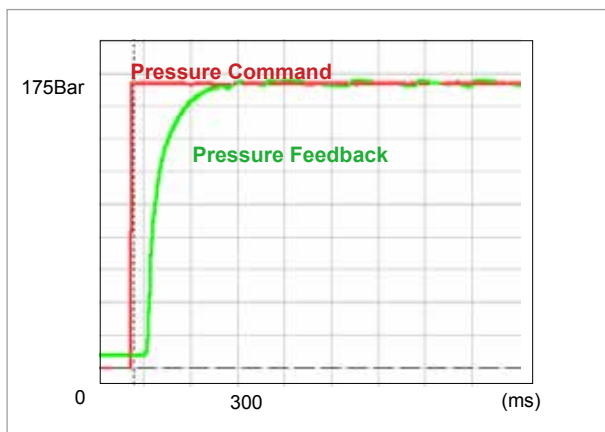

(5) Field-Weakening Control of a Motor

- Delta's servo drive uses motor field-weakening control to effectively extend the motor operation scope, increase system flow and ensure productivity of the injection molding machine.

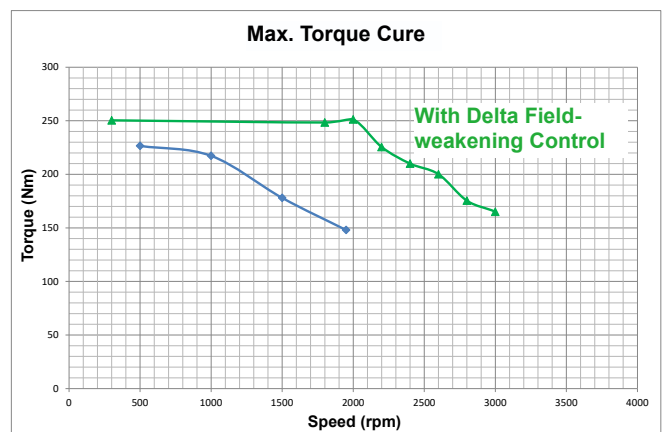

(6) Easy Commissioning

- Users can directly use the Delta preset motor and hydraulic system parameters without the need for additional tuning, simply install the drive to easily begin the operation.

(7) Excellent Performance

- Short response time enhances response speed of the system
- Great V/P transfer capability elevates product yield rate
- Lower noise compared with traditional dosing pump
- Stable oil temperature rise

(8) S-Curve Control

- Smooth operation reduces machine vibration

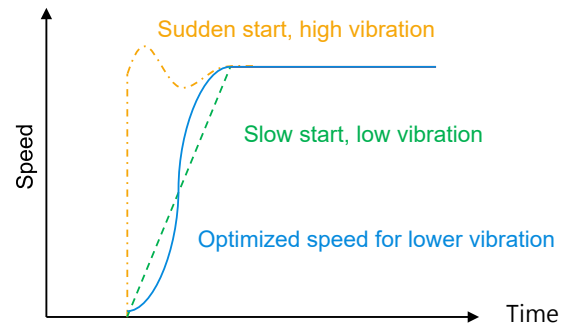

(9) Multiple Protections

- Multiple protection functions, including over current, over/low voltage, over heating, brake protection, insufficient pump oil protection. Complete protection prevents the equipment from anomalies and serious malfunction, and enhances system lifetime.
- Real-time monitoring of the motor temperature via KTY84-130 temperature sensor embedded in the motor winding.

(10) Multiple Pumps Control

- Capable of controlling up to 12 pumps and multiple master/slave pumps system architecture. Users can integrate systems with a different HES-C flow rate depending upon the system requirements of the machines.

(11) User-Friendly Software

- User-friendly software for machine commissioning. The software presents real-time system parameters such as pressure, flow, motor current and motor speed.



(12) System Monitoring and Controller Integration

- Built-in PG and communication card, and USB port to connect industrial 3G routers for system monitoring and software upgrade.
- Supports CANopen communication protocol, enhancing integration with the controllers

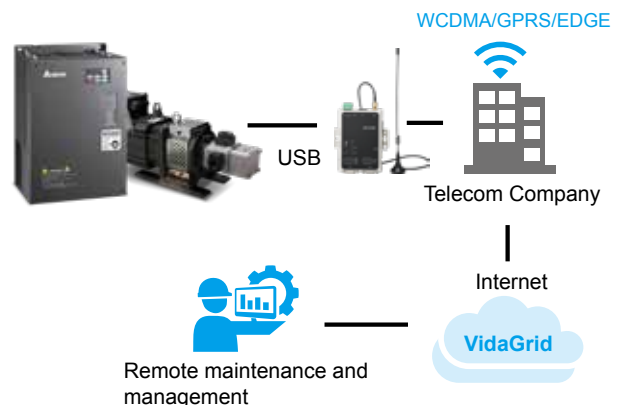

* CANopen only applicable for VJ-C

System Structure

Hybrid Servo Drive + AC Servo Motor + Internal Gear Pump + Pressure Sensor with PID controls
 The system provides precise pressure and speed control and fast response time to ensure high duplication accuracy.

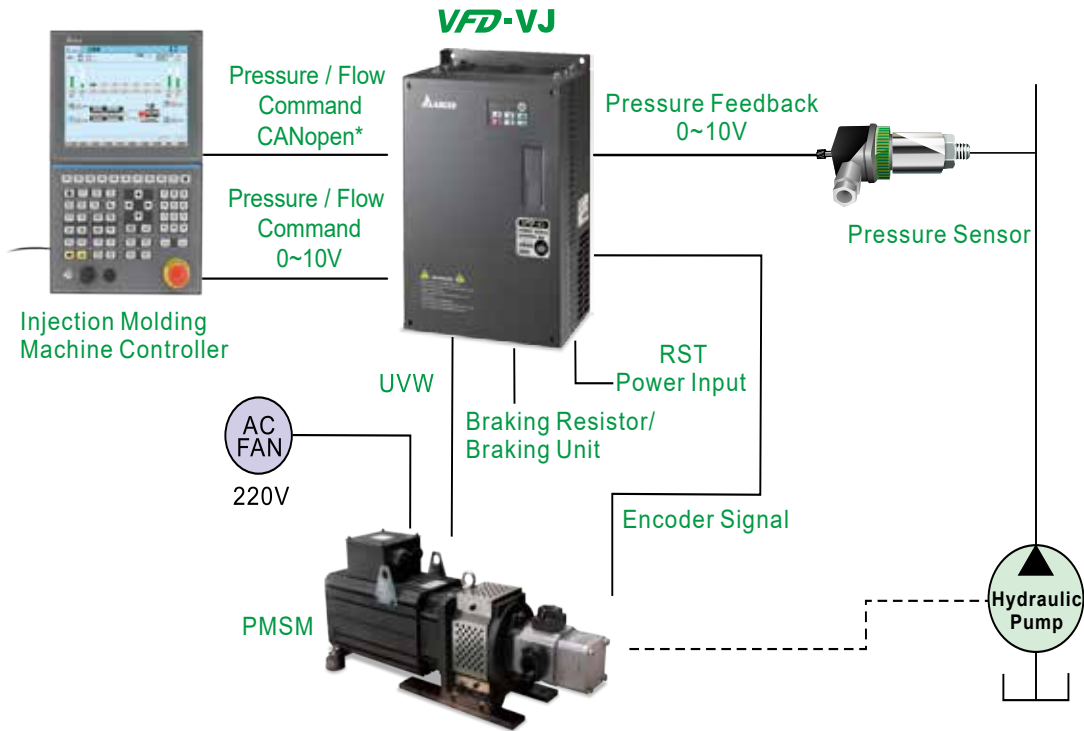

Multi-pump Convergent Flow Control

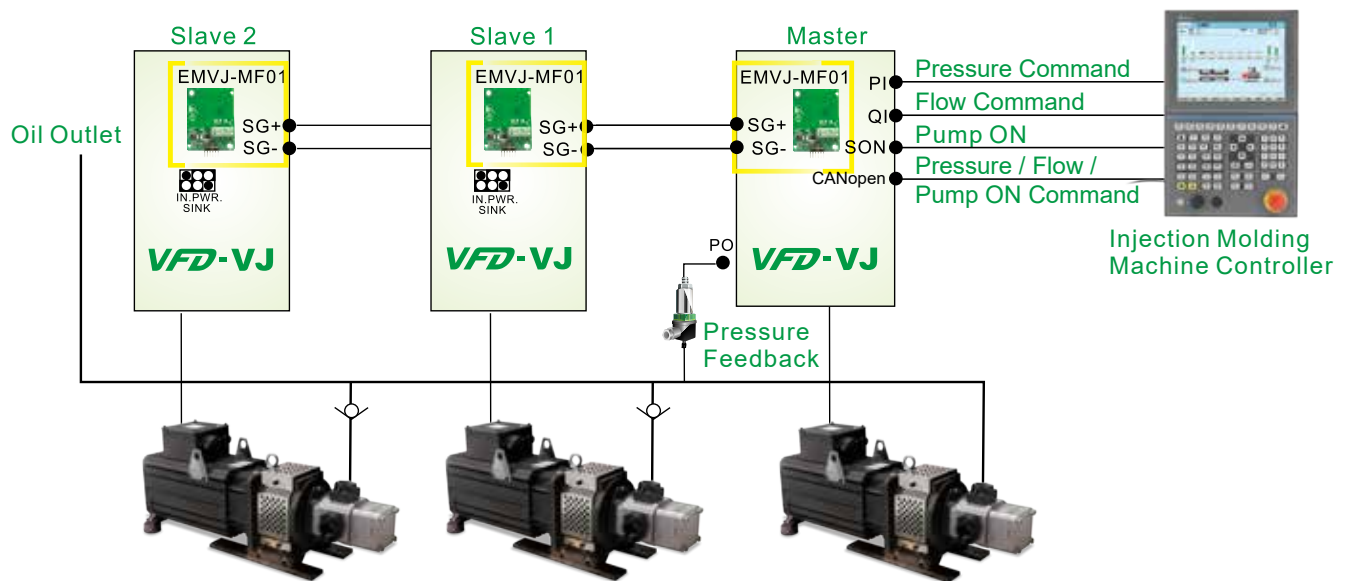

* No additional EMVJ-MF01 required for VJ-C

Multi-pump Control

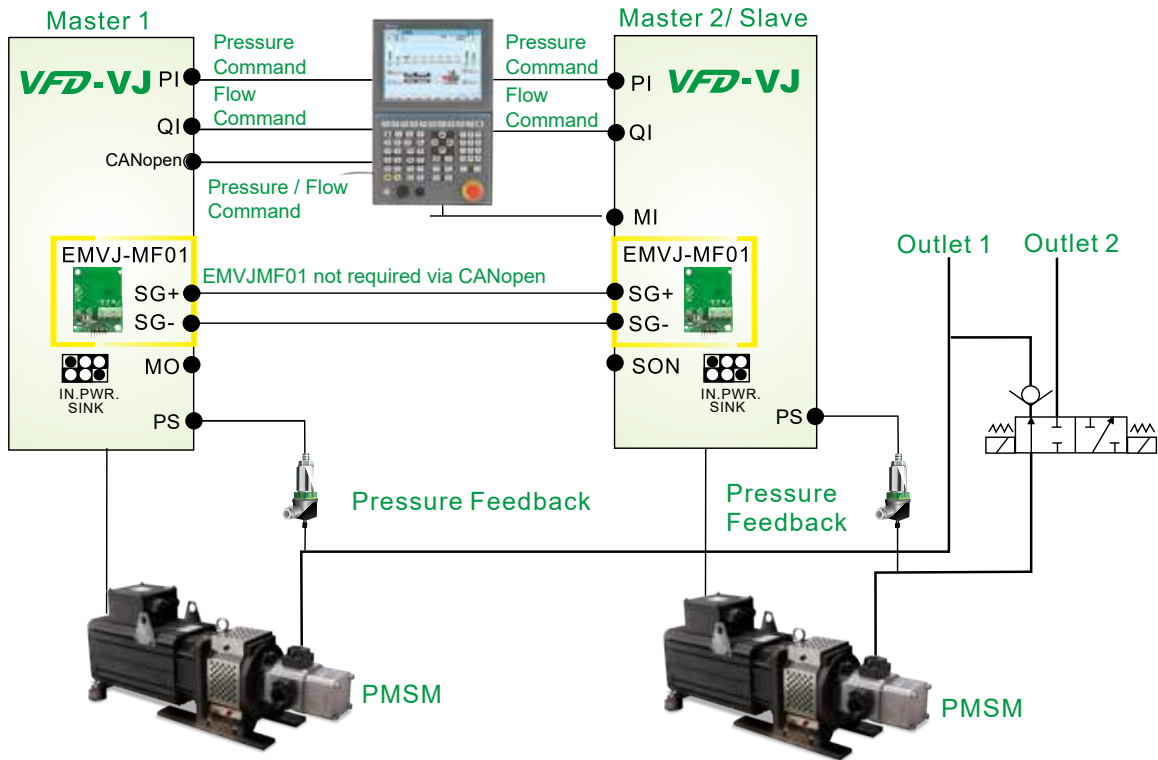

Note 1 : EMVJ-MF01 is not required for the Servo Drive VFD-VJ-C Series.

Note 2 : The pressure sensor terminal of the Servo Drive VJ-A Series is PO. The pressure sensor terminal of the Servo Drive VJ-C Series is PS.

Model Number Explanation

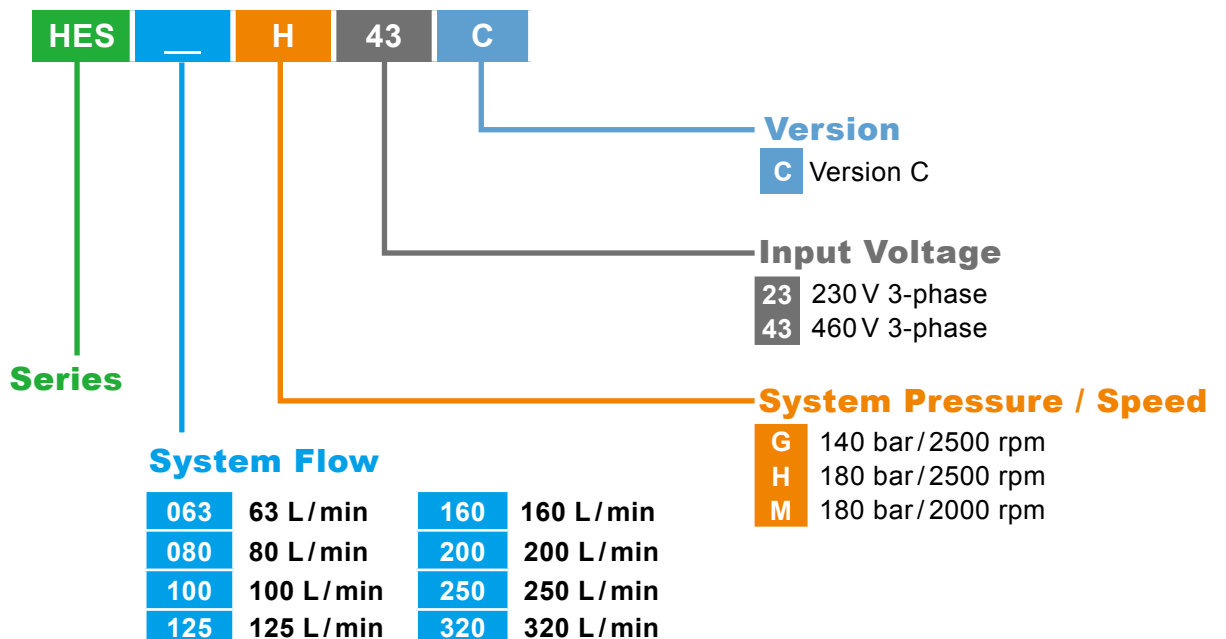

Pressure/Flow Characteristic Chart

230V System (Under normal operating conditions)*

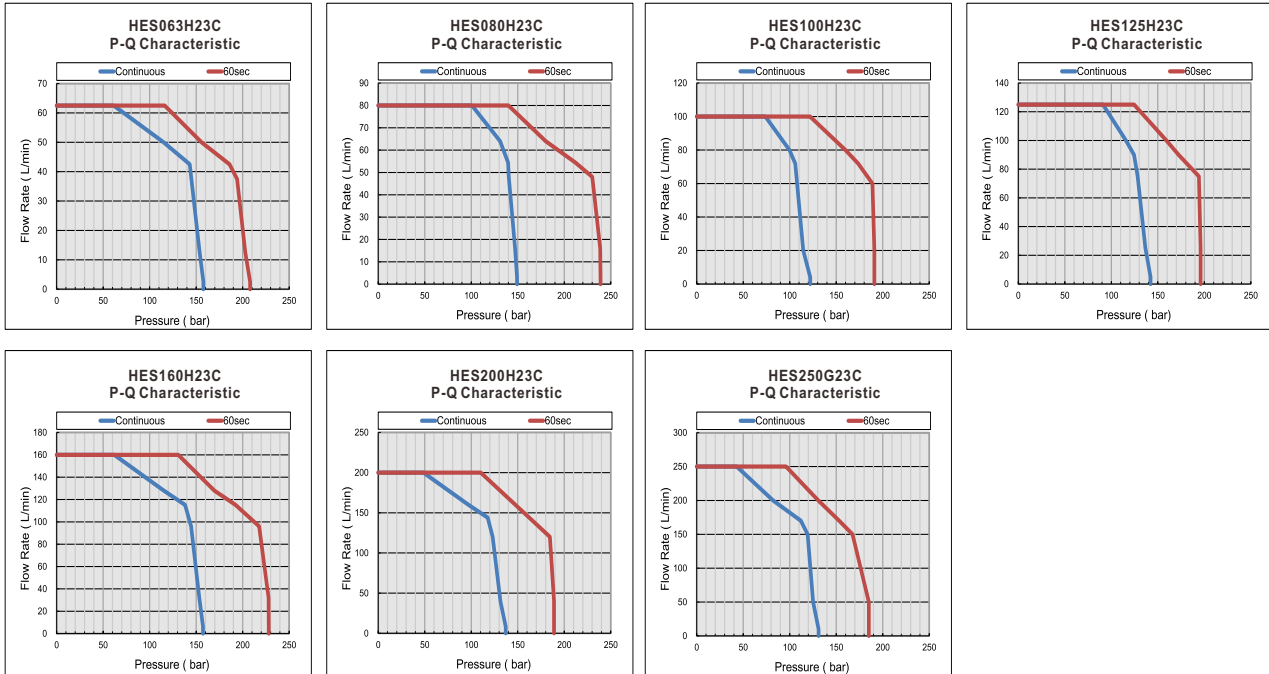





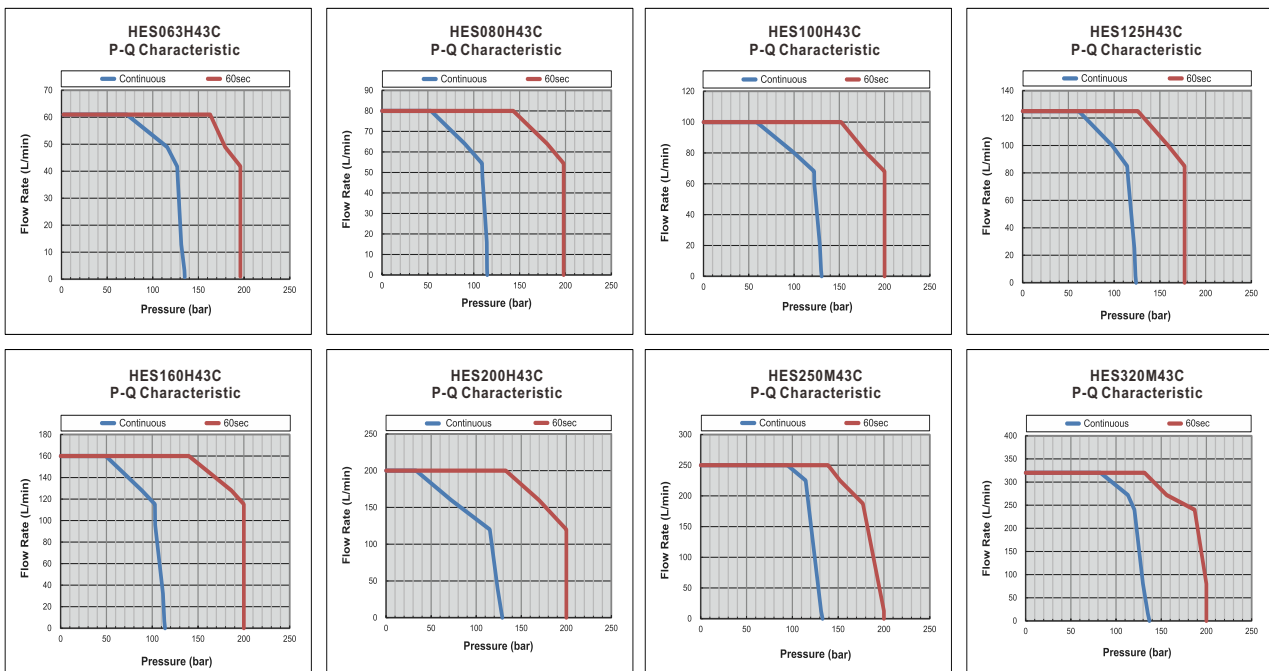







* This is an example of injection molding machine operating at 220VAC in normal condition. The performance may vary if applied under special conditions or in harsh environment.

460V System (Under normal operating conditions)*



* This is an example of an injection molding machine operating at 380VAC in normal conditions. The performance may vary upon environment conditions.

System Specifications

230V										
Model HES ___ 23C			063H	080H	100H	125H	160H	200H	250G	
Flow	Pump Volume	cc/rev	25	32	40	50	64	80	100	
	Flow Rate	L/min	63	80	100	125	160	200	250	
	Linearity	%	Lower than 1% F.S.							
	Hysteresis	%	Lower than 1% F.S.							
Pressure	Max. Pressure	Mpa	18						14	
	Min. Pressure	Mpa	0.1							
	Linearity	%	Lower than 1% F.S.							
	Hysteresis	%	Lower than 1% F.S.							
Motor	Power	kW	10	14	18	23	27	27		
	Insulation Class		Class F							
	Certifications									
	Cooling Method		Forced Air Cooling							
	Operating Environment		Ambient Temperature 0~40 °C, Ambient Humidity 20~90% RH(Non-condensation), Altitude <1000m							
	Weight of Pump and Motor	kg	83	90	97	105	121	145		
Hybrid Servo Controller	Model	VFD-___VL23  (L) VFD-___VJ23  (L)	110  (06HC)	150  (08HC)	150  (10HC)	220  (12HC)	300  (16HC)	300  (20HC)	370  (25GC)	
	Operation Voltage		3-phase voltage: 220~240 VAC, 50/60 Hz							
	Output Power	kW	11	15	15	22	30	30	37	
	Braking Unit		Built-in							
	Braking Resistor	W Ω	300 8.3	1000 5.8						
	Speed Detector		Resolver							
	Pressure Input		0 ~ 10V support 3-point adjustment for analog inputs				0 ~ 10V support 3-point adjustment for analog inputs/CANopen			
	Flow Input		0 ~ 10V support 3-point adjustment for analog inputs				0 ~ 10V support 3-point adjustment for analog inputs/CANopen			
	Multi-function Input Terminal		5ch DC24V 8mA				6ch DC24V 8mA / 1 RJ45 (RS485) 1 RJ45 (CANopen)			
	Multi-function Output Terminal		2 ch DC24V 50mA, 1 ch Relay output				2 ch DC48V 50mA (max) · 1 ch Relay output / 1 RJ45 (RS485) 1 RJ45 (CANopen)			
	Analog Output Voltage		2 ch DC 0 ~ 10V				1ch DC 0~10V (AFM1) 1ch DC -10~10V (AFM2) / 1 RJ45 (RS485) 1 RJ45 (CANopen)			
	Cooling System		Forced air cooling							
	Protections		Over current, over voltage, low voltage, overload or overheating of servo controller, overload or overheating of motor, operation speed error, insufficient pump oil							
	Certifications									
Oil	Working Fluid		HL-HLP DIN51524 Part1/2 R68, R46							
	Operation Temperature	°C	-12 to 100 °C							
	Viscosity	@40 °C @100 °C	67.83 8.62							
Others		Optional: safety valve, reactor and EMC filters								

*Note 1: Delta reserves the right to change product specifications.

460V											
Model HES___43C			063H	080H	100H	125H	160H	200H	250M	320M	
Flow	Pump Volume	cc/rev	25	32	40	50	64	80	125	160	
	Flow Rate	L/min	63	80	100	125	160	200	250	320	
	Linearity	%	Lower than 1% F.S.								
	Hysteresis	%	Lower than 1% F.S.								
Pressure	Max. Pressure	Mpa	18								
	Min. Pressure	Mpa	0.1								
	Linearity	%	Lower than 1% F.S.								
	Hysteresis	%	Lower than 1% F.S.								
Motor	Power	kW	10	14	18	23	25	45	52		
	Insulation Class		Class F								
	Certifications										
	Cooling Method		Forced Air Cooling								
	Operating Environment		Ambient Temperature 0~40°C, Ambient Humidity 20~90% RH(Non-condensation), Altitude <1000m								
	Weight of Pump and Motor	kg	83	90	97	105	121	206	224		
Hybrid Servo Controller	Model VFD-___VJ43_()		110☐ (06HC)	150☐ (08HC)	185☐ (10HC)	220☐ (12HC)	300☐ (16HC)	300☐ (20HC)	550☐ (25MC)	550☐ (32MC)	
	Operation Voltage		3-phase voltage: 380~460 VAC, 50/60Hz								
	Output Power	kW	11	15	18.5	22	30	30	55	55	
	Braking Unit		Built-in								
	Braking Resistor	W	300	1000				1500			
		Ω	25				19				
	Speed Detector		Resolver								
	Pressure Input		0 ~ 10 V support 3-point adjustment for analog inputs/CANopen								
	Flow Input		0 ~ 10 V support 3-point adjustment for analog inputs/CANopen								
	Multi-function Input Terminal		6 ch DC24V 8mA / 1 RJ45 (RS485) 1 RJ45 (CANopen)								
	Multi-function Output Terminal		2 ch DC48V 50mA (max) · 1 ch Relay output / 1 RJ45 (RS485) 1 RJ45 (CANopen)								
	Analog Output Voltage		1ch DC 0~10V (AFM1) 1ch DC -10~10V (AFM2) / 1 RJ45 (RS485) 1 RJ45 (CANopen)								
	Cooling System		Forced air cooling								
	Protections		Over current, over voltage, low voltage, overload or overheating of servo controller, overload or overheating of motor, operation speed error, insufficient pump oil								
Certifications											
Oil	Working Fluid		HL-HLP DIN51524 Part1/2 R68, R46								
	Operation Temperature	°C	-12 to 100 °C								
	Viscosity	@40°C	67.83								
@100°C		8.62									
Others		Optional: safety valve, reactor and EMC filters									

*Note 1: Delta reserves the right to change product specifications.

Wiring

HES063H23C~HES125H23C

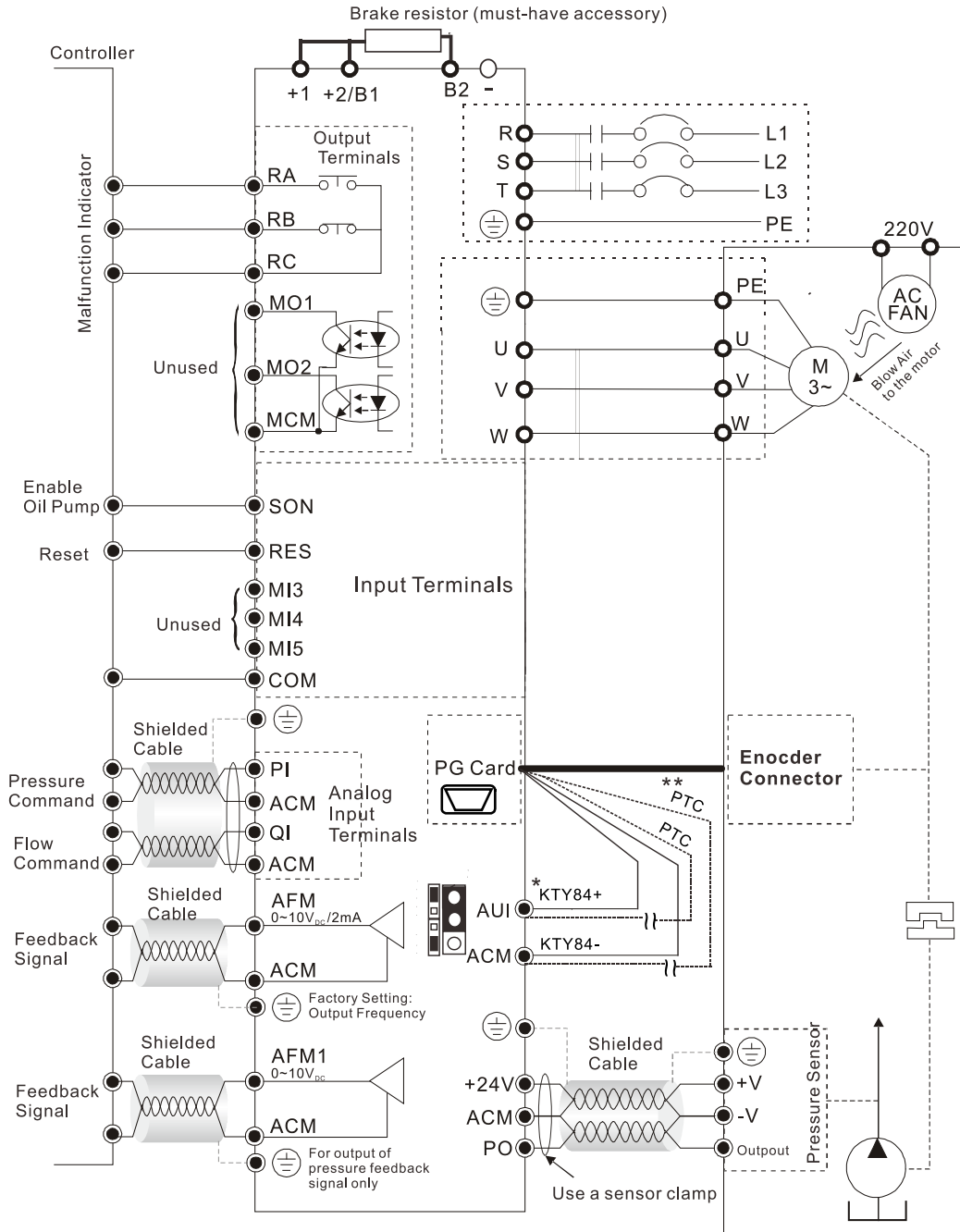

***Note :** For HES063H23C ~ HES250G23C
HES125H43C ~ HES320M43C

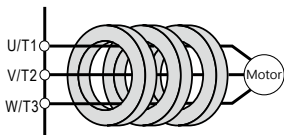

HES160H23C~HES250G23C HES063H43C~HES320M43C

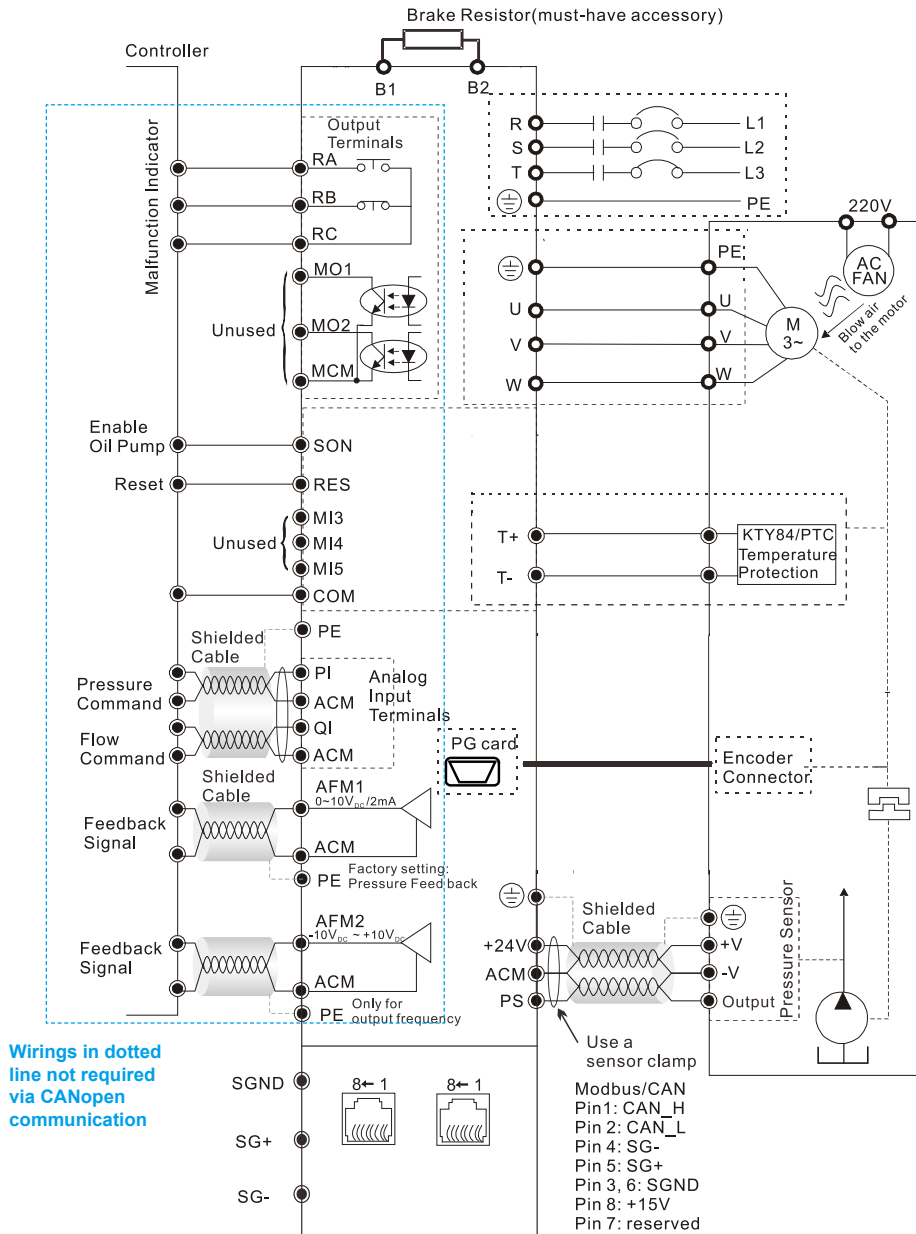

***Note 1:** For HES063H43C ~ HES100H43C (Please winding the wire through the zero phase reactor at least 3 turns before connecting to the motor)

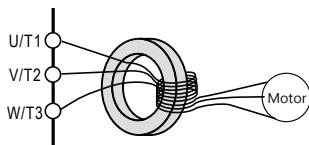

For HES063H23C ~ HES250G23C
HES125H43C ~ HES320M43C

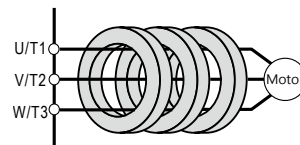

***Note 2:** The KTY84 temperature sensor is used; be ware of the polarities. The colors of the motor encoder wire CBHE-E5M are: black/white for KTY-, red/white for KTY+, yellow/black for PTC, and yellow for PTC.

Dimensions

Hybrid Servo Controller

Frame C

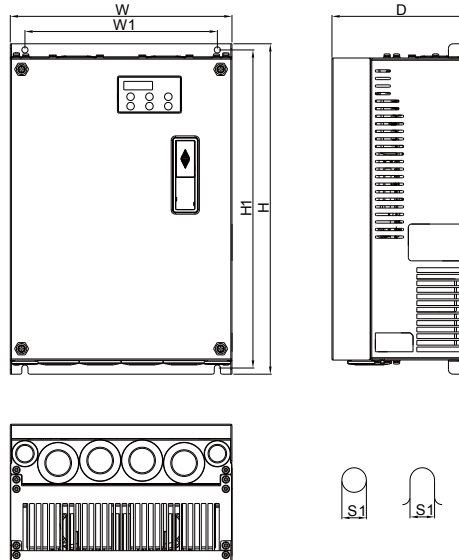

MODEL

VFD110VL23Axxxx
 VFD110VJ43Cxxxx
 VFD150VJ43Cxxxx
 VFD185VJ43Cxxxx
 VFD220VJ43Cxxxx

Unit: mm [inch]

Frame		W	H	D	W1	H1	S1
C	mm	235	350	146	204	337	6.5
	inch	9.25	13.78	5.75	8.03	13.27	0.26

Frame D

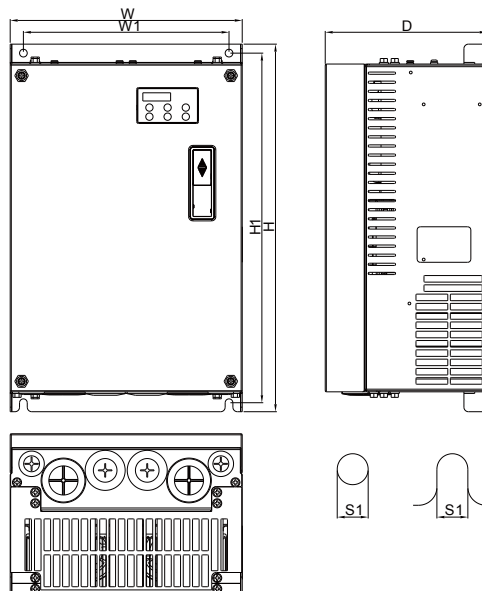

MODEL

VFD150VL23Axxxx
 VFD220VL23Axxxx
 VFD300VJ43Cxxxx

Unit: mm [inch]

Frame		W	H	D	W1	H1	S1
D	mm	255	403.8	178	226	384	8.5
	inch	10.04	15.90	6.61	8.90	15.12	0.33

Frame E4

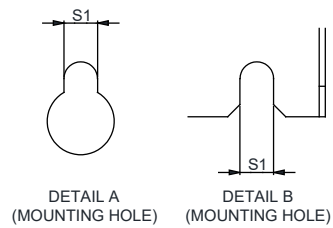
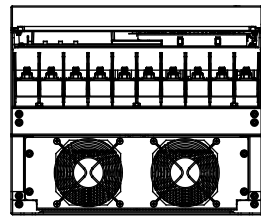
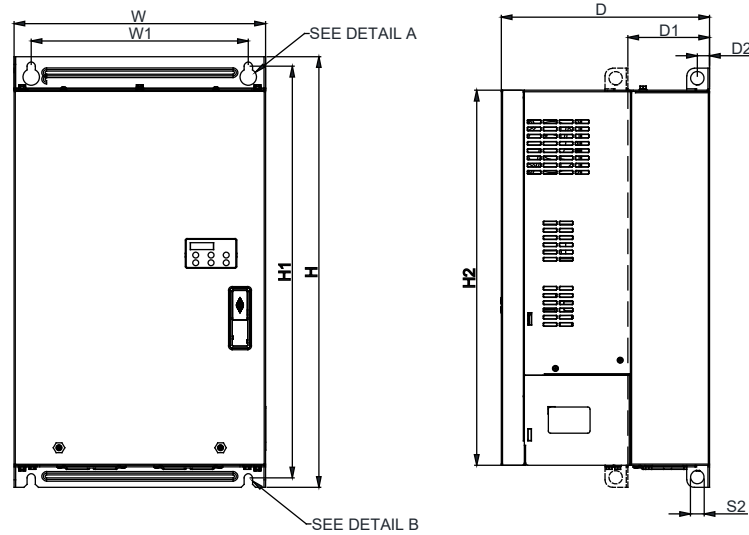

MODEL

VFD300VJ23Cxxxx
VFD370VJ23Cxxxx
VFD550VJ43Cxxxx

Unit: mm [inch]

Frame		W	W1	H	H1	H2	D	D1*	D2	S1	S2
E4	mm	330.0	285.0	565.0	540.0	492.0	273.4	107.2	16.0	11.0	18.0
	inch	12.99	11.22	22.24	20.67	19.37	10.76	4.22	0.63	0.43	0.71

Dimensions

Servo Pump

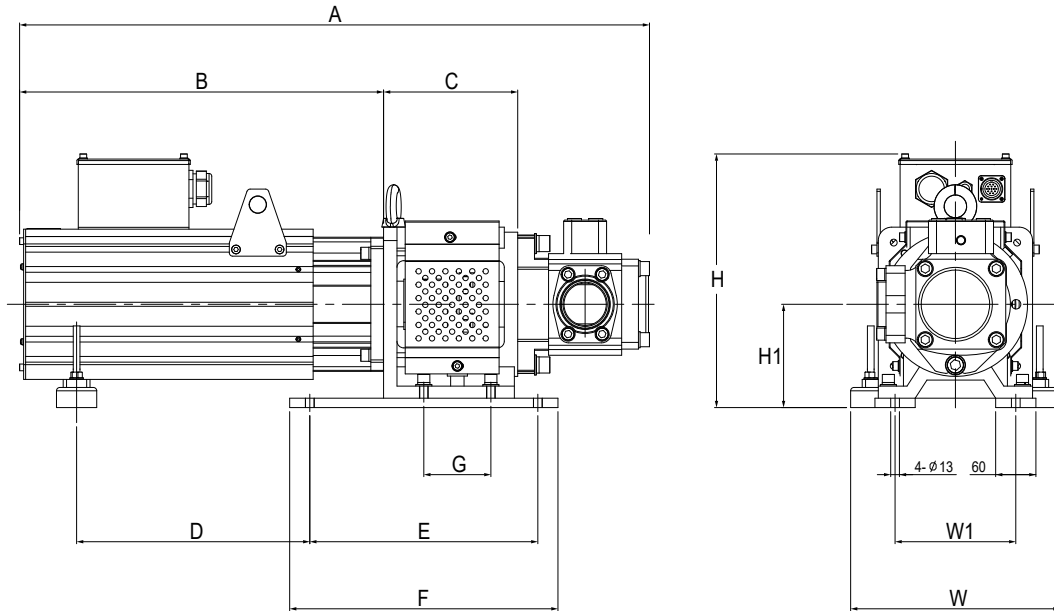

Unit : mm

HES Model	A	B	C	D	E	F	G	H	H1	W	W1	Inlet	Outlet
HES063H23C	695	381	170	194	340	400	95	376	154	314	180	1-1/4" PT	3/4" PT
HES080H23C	741	417	170	219	340	400	95	376	154	314	180	1-1/4" PT	3/4" PT
HES100H23C	752	417	170	219	340	400	95	376	154	314	180	1-1/4" PT	1" PT
HES125H23C	802	453	170	259	340	400	95	376	154	314	180	1-1/4" PT	1" PT
HES160H23C	859	489	170	304	340	400	95	376	154	314	180	1-1/4" PT	1" PT
HES200H23C	956	575	200	399	340	400	100	376	154	314	180	2" PT	1-1/4" PT
HES250G23C	972	575	200	399	340	400	100	376	154	314	180	2-1/2" PT	1-1/4" PT
HES063H43C	695	381	170	194	340	400	95	376	154	314	180	1-1/4" PT	3/4" PT
HES080H43C	705	381	170	194	340	400	95	376	154	314	180	1-1/4" PT	3/4" PT
HES100H43C	752	417	170	219	340	400	95	376	154	314	180	1-1/4" PT	1" PT
HES125H43C	802	453	170	259	340	400	95	376	154	314	180	1-1/4" PT	1" PT
HES160H43C	859	489	170	304	340	400	95	376	154	314	180	1-1/4" PT	1" PT
HES200H43C	956	575	200	399	340	400	100	376	154	314	180	2" PT	1-1/4" PT
HES250M43C	1028	577	230	275	420	500	140	458	184	426	250	2-1/2" PT	1-1/2" PT
HES320M43C	1098	631	230	327	420	500	140	456	184	426	250	3" PT	1-1/2" PT

*Note: Size of the Model D can be adjusted based on requirements

Accessories

Accessory Pack

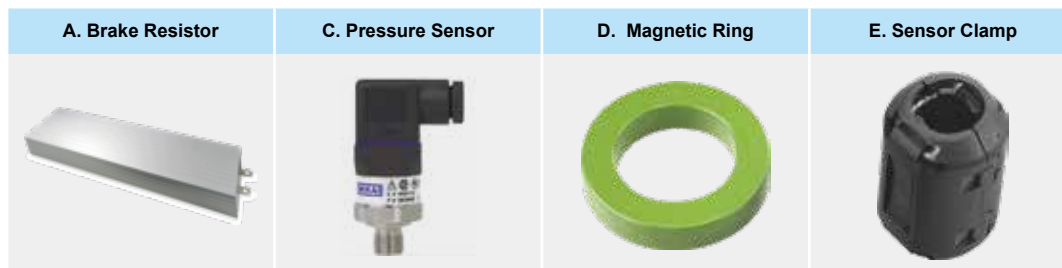

Product Packages

Model Name	Package Items		
	Hybrid Servo Controller	Servo Pump*	Accessory Items**
			
HES063H23C	VFD110VL23A06HC	HSP-025-100-23C	HESP-063-H-NC23 Item: A, C, Dx3, E
HES080H23C	VFD150VL23A08HC	HSP-032-140-23C	HESP-080-H-NC23 Item: A, C, Dx3, E
HES100H23C	VFD150VL23A10HC	HSP-040-140-23C	HESP-100-H-NC23 Item: A, C, Dx3, E
HES125H23C	VFD220VL23A12HC	HSP-050-180-23C	HESP-125-H-NC23 Item: A, C, Dx3, E
HES160H23C	VFD300VJ23C16HC	HSP-064-230-23C	HESP-160-H-NC23 Item: A, C, Dx3, E
HES200H23C	VFD300VJ23C20HC	HSP-080-270-23C	HESP-200-H-NC23 Item: A, C, Dx3, E
HES250G23C	VFD370VJ23C25GC	HSP-100-270-23C	HESP-250-G-NC23 Item: A, C, Dx3, E
HES063H43C	VFD110VJ43C06HC	HSP-025-100-43C	HESP-063-H-NC43 Item: A, C, D, E
HES080H43C	VFD150VJ43C08HC	HSP-032-100-43C	HESP-080-H-NC43 Item: A, C, D, E
HES100H43C	VFD185VJ43C10HC	HSP-040-140-43C	HESP-100-H-NC43 Item: A, C, D, E
HES125H43C	VFD220VJ43C12HC	HSP-050-180-43C	HESP-125-H-NC43 Item: A, C, Dx3, E
HES160H43C	VFD300VJ43C16HC	HSP-064-230-43C	HESP-160-H-NC43 Item: A, C, Dx3, E
HES200H43C	VFD300VJ43C20HC	HSP-080-250-43C	HESP-200-H-NC43 Item: A, C, Dx3, E
HES250M43C	VFD550VJ43C25MC	HSP-125-450-43C	HESP-250-M-NC43 Item: A, C, Dx3, E
HES320M43C	VFD550VJ43C32MC	HSP-160-520-43C	HESP-320-M-NC43 Item: A, C, Dx3, E

*Note 1: Encoder cables (CBHE-E5M, P/N: 3865345000) included in the Servo Pump HSP package

**Note 2: The standard thread for pressure sensor is PT thread. G thread is available upon request, please contact Delta sales for details.



Smarter. Greener. Together.

Industrial Automation Headquarters

Delta Electronics, Inc.

Taoyuan Technology Center
No.18, Xinglong Rd., Taoyuan District,
Taoyuan City 33068, Taiwan
TEL: 886-3-362-6301 / FAX: 886-3-371-6301

Asia

Delta Electronics (Shanghai) Co., Ltd.

No.182 Minyu Rd., Pudong Shanghai, P.R.C.
Post code : 201209
TEL: 86-21-6872-3988 / FAX: 86-21-6872-3996
Customer Service: 400-820-9595

Delta Electronics (Japan), Inc.

Tokyo Office
Industrial Automation Sales Department
2-1-14 Shibadaimon, Minato-ku
Tokyo, Japan 105-0012
TEL: 81-3-5733-1155 / FAX: 81-3-5733-1255

Delta Electronics (Korea), Inc.

Seoul Office
1511, 219, Gasan Digital 1-Ro., Geumcheon-gu,
Seoul, 08501 South Korea
TEL: 82-2-515-5305 / FAX: 82-2-515-5302

Delta Energy Systems (Singapore) Pte Ltd.

4 Kaki Bukit Avenue 1, #05-04, Singapore 417939
TEL: 65-6747-5155 / FAX: 65-6744-9228

Delta Electronics (India) Pvt. Ltd.

Plot No.43, Sector 35, HSIIDC Gurgaon,
PIN 122001, Haryana, India
TEL: 91-124-4874900 / FAX : 91-124-4874945

Delta Electronics (Thailand) PCL.

909 Soi 9, Moo 4, Bangpoo Industrial Estate (E.P.Z),
Pattana 1 Rd., T.Phraksa, A.Muang,
Samutprakarn 10280, Thailand
TEL: 66-2709-2800 / FAX : 662-709-2827

Delta Electronics (Australia) Pty Ltd.

Unit 20-21/45 Normanby Rd., Notting Hill Vic 3168, Australia
TEL: 61-3-9543-3720

Americas

Delta Electronics (Americas) Ltd.

Raleigh Office
P.O. Box 12173, 5101 Davis Drive,
Research Triangle Park, NC 27709, U.S.A.
TEL: 1-919-767-3813 / FAX: 1-919-767-3969

Delta Electronics Brazil

São Paulo Sales Office
Rua Itapeva, 26 - 3º, andar Edifício Itapeva,
One - Bela Vista 01332-000 - São Paulo - SP - Brazil
TEL: 55-12-3932-2300 / FAX: 55-12-3932-237

Delta Electronics International Mexico S.A. de C.V.

Mexico Office
Gustavo Baz No. 309 Edificio E PB 103
Colonia La Loma, CP 54060
Tlalnepantla, Estado de México
TEL: 52-55-3603-9200

EMEA

Headquarters: Delta Electronics (Netherlands) B.V.

Sales: Sales.IA.EMEA@deltaww.com
Marketing: Marketing.IA.EMEA@deltaww.com
Technical Support: iatechnicalsupport@deltaww.com
Customer Support: Customer-Support@deltaww.com
Service: Service.IA.emea@deltaww.com
TEL: +31(0)40 800 3900

BENELUX: Delta Electronics (Netherlands) B.V.

De Witbogt 20, 5652 AG Eindhoven, The Netherlands
Mail: Sales.IA.Benelux@deltaww.com
TEL: +31(0)40 800 3900

DACH: Delta Electronics (Netherlands) B.V.

Coesterweg 45, D-59494 Soest, Germany
Mail: Sales.IA.DACH@deltaww.com
TEL: +49(0)2921 987 0

France: Delta Electronics (France) S.A.

ZI du bois Challand 2, 15 rue des Pyrénées,
Lisses, 91090 Evry Cedex, France
Mail: Sales.IA.FR@deltaww.com
TEL: +33(0)1 69 77 82 60

Iberia: Delta Electronics Solutions (Spain) S.L.U

Ctra. De Villaverde a Vallecas, 265 1º Dcha Ed.
Hormigueras – P.I. de Vallecas 28031 Madrid
TEL: +34(0)91 223 74 20

Carrer Llacuna 166, 08018 Barcelona, Spain

Mail: Sales.IA.Iberia@deltaww.com

Italy: Delta Electronics (Italy) S.r.l.

Via Meda 2-22060 Novedrate(CO)
Piazza Grazioli 18 00186 Roma Italy
Mail: Sales.IA.Italy@deltaww.com
TEL: +39 039 8900365

Russia: Delta Energy System LLC

Vereyskaya Plaza II, office 112 Vereyskaya str.
17 121357 Moscow Russia
Mail: Sales.IA.RU@deltaww.com
TEL: +7 495 644 3240

Turkey: Delta Greentech Elektronik San. Ltd. Sti. (Turkey)

Şerifaii Mah. Hendem Cad. Kule Sok. No:16-A
34775 Ümraniye – İstanbul
Mail: Sales.IA.Turkey@deltaww.com
TEL: + 90 216 499 9910

GCC: Delta Energy Systems AG (Dubai BR)

P.O. Box 185668, Gate 7, 3rd Floor, Hamarain Centre
Dubai, United Arab Emirates
Mail: Sales.IA.MEA@deltaww.com
TEL: +971(0)4 2690148

Egypt + North Africa: Delta Electronics

Unit 318, 3rd Floor, Trivium Business Complex, North 90 street,
New Cairo, Cairo, Egypt
Mail: Sales.IA.MEA@deltaww.com